

## INSTRUCTIONS FOR USE, NÁVOD K POUŽITÍ

MOTOR STARTER  
SPOUŠTĚČ MOTORU



# SM123...

1

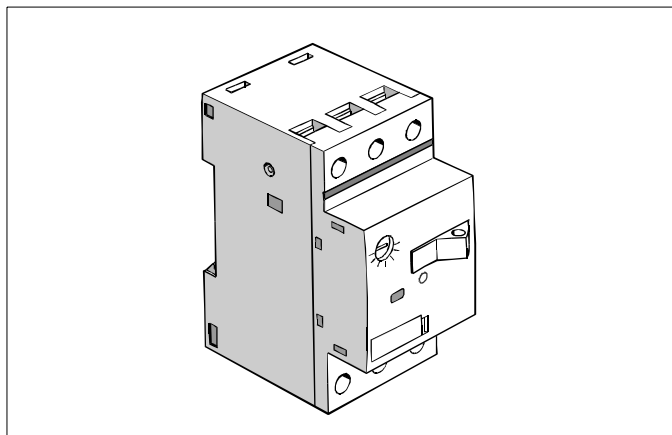

**Installation, service and maintenance of the electrical equipment may be carried out by an authorized person only.**

Montáž, obsluhu a údržbu smí provádět jen osoba s odpovídající elektrotechnickou kvalifikací.

DIN EN 60715

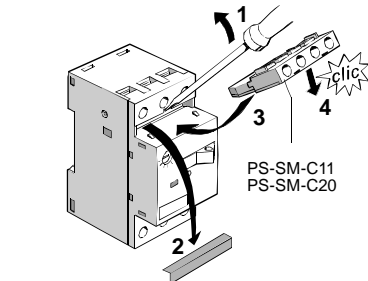
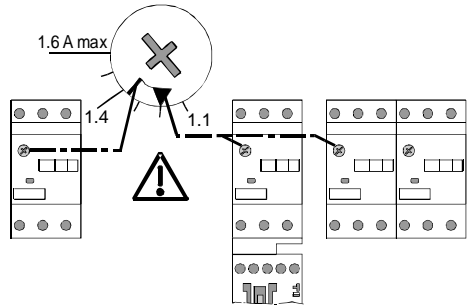
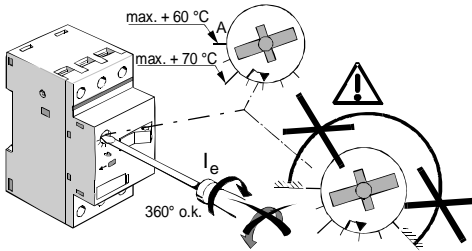
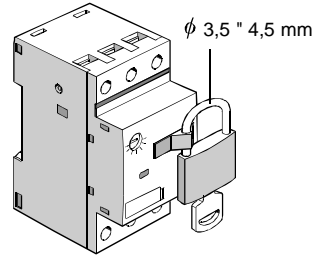
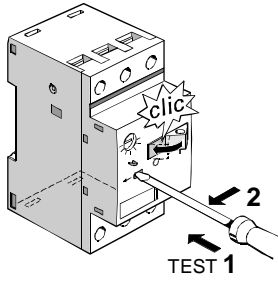
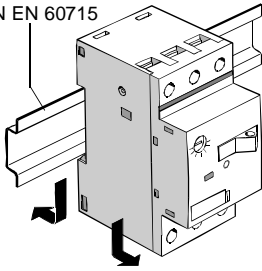



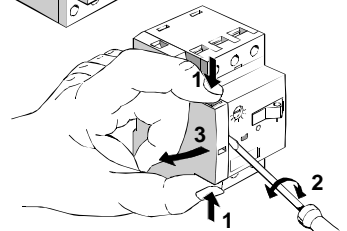
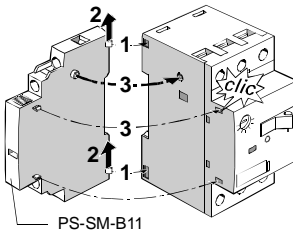
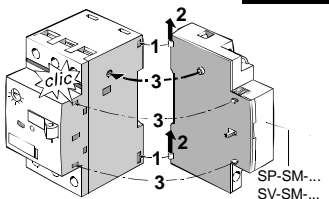
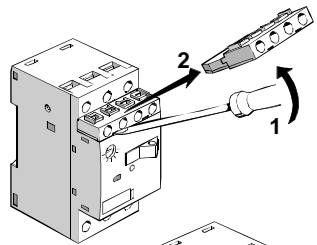

NC/NO: max. ks / pc.	
max.1: PS-SM-B11	max.1: PS-SM-C11 PS-SM-C20

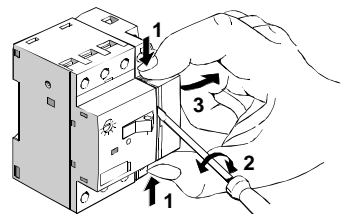
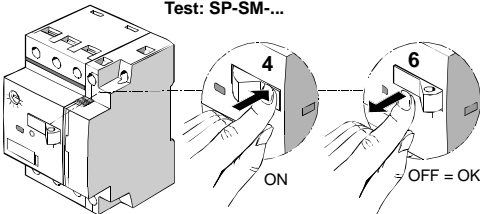

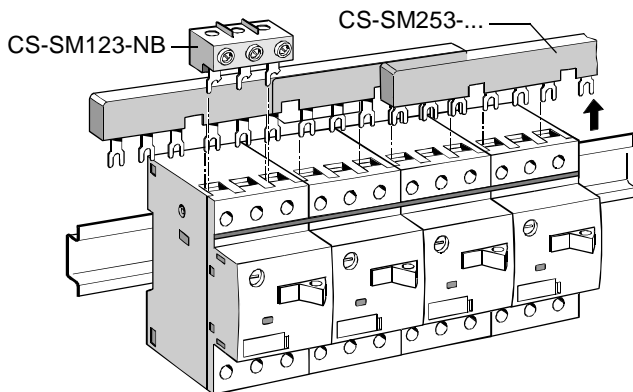
Test: SP-SM...





	SM123-... PS-SM-...	CS-SM123-NB
 $\phi$ 5 ... 6 mm / PZ2	0,8 ... 1,2 Nm 7 to 10.3 lb·in	2 ... 4 Nm 17.6 to 35.2 lb·in
	2 x 0,5 ... 1,5 mm. 2 x 0,75 ... 2,5 mm. max. 2 x 1 ... 4 mm.	2,5 ... 25 mm.
	2 x 0,5 ... 2,5 mm.	2,5 ... 16 mm.

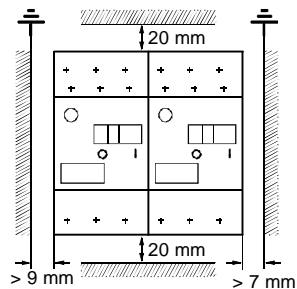
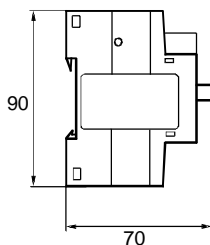
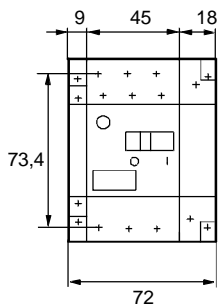
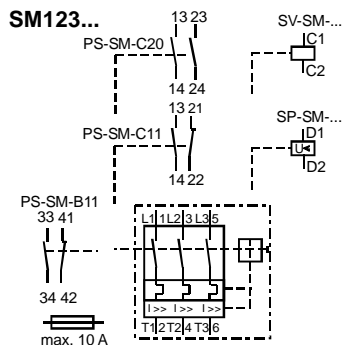

**2** Only materials which have low adverse environmental impact and which do not contain dangerous substances as specified in ROHS directive have been used in the product.

Ve výrobku jsou použity materiály s nízkým negativním dopadem na životní prostředí, které neobsahují zakázané nebezpečné látky dle ROHS.



**SLOVENSKY**

**ПО-РУССКИ**

**SM123**

## **Návod k použitiu**

**SLOVENSKY**

### **Spúšťáč motora - SM123**

- 1** Montáž, obsluhu a údržbu môže vykonávať iba osoba s odpovedajúcou elektrotechnickou kvalifikáciou.
- 2** Vo výrobku sú použité materiály s nízkym negatívnym dopadom na životné prostredie, ktoré neobsahuje zakázané latky podľa ROHS

## **Инструкция по эксплуатации**

**ПО-РУССКИ**

### **Автоматический выключатель защиты двигателя - SM123**

- 1** Установку, обслуживание и уход может проводить только лицо с соответствующей электротехнической квалификацией.
- 2** В изделии применены материалы с малым негативным влиянием на окружающую среду, которые не содержат запрещенные опасные вещества, указанные в директиве ROHS.