

INSTRUCTIONS FOR USE, NÁVOD K POUŽITÍ

MOTOR STARTER
SPOUŠTĚČ MOTORU



SM253...

1

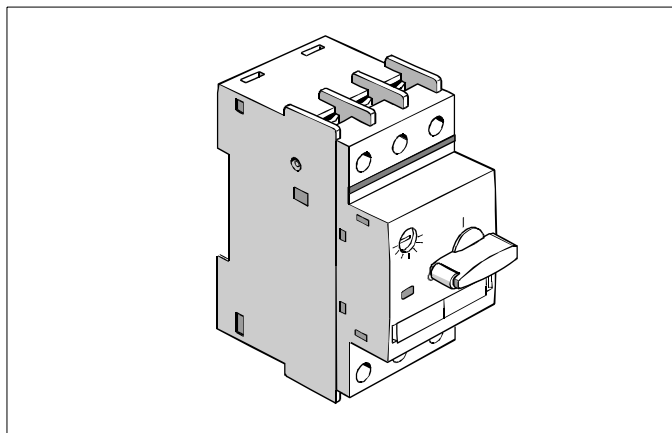

Installation, service and maintenance of the electrical equipment may be carried out by an authorized person only.

Montáž, obsluhu a údržbu smí provádět jen osoba s odpovídající elektrotechnickou kvalifikací.

DIN EN 60715

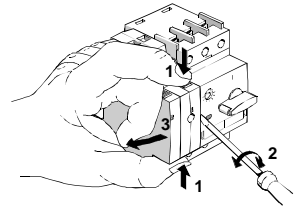
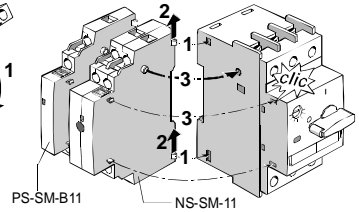
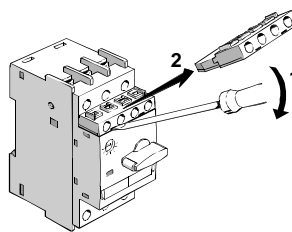
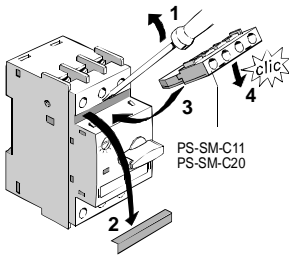
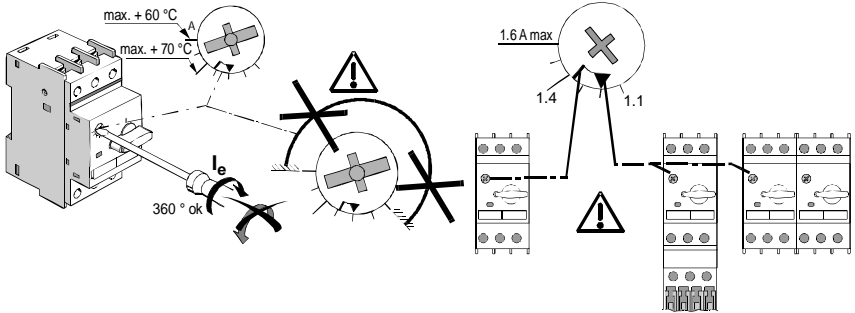
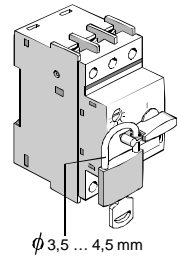
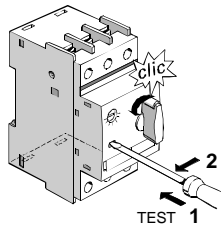
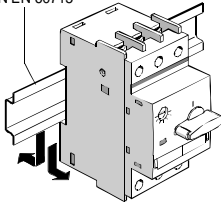

NC/NO: max. ks / pc.	
max.1: PS-SM-B11	+ max.1: PS-SM-C11 PS-SM-C20

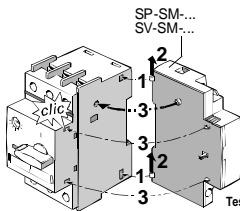

Test: SP-SM...

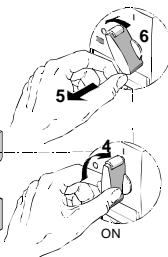
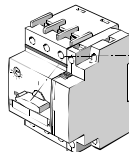



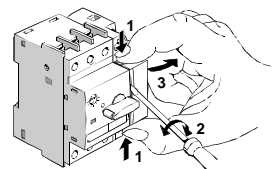

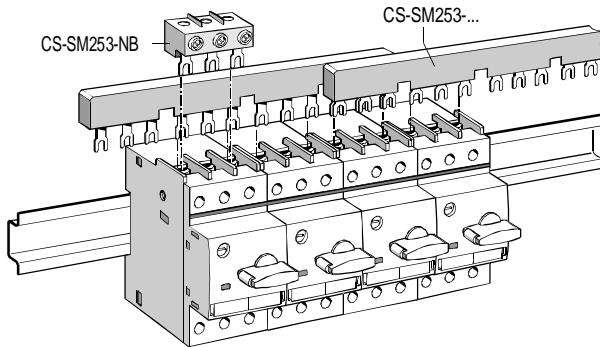
2 TRIPPED = OK
VYBAVENO=OK



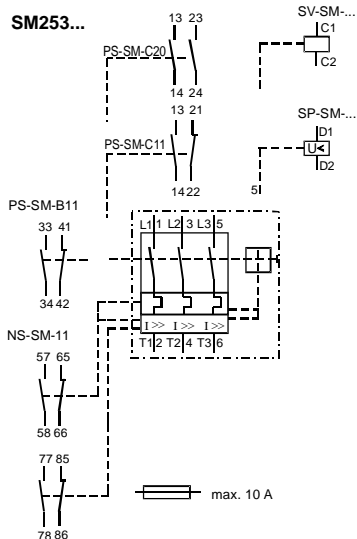

SM253...



	L1 L2 L3 T1 T2 T3	D1, D2, C1, C2, NO/NC PS-SM-...	CS-SM253-NB
	2 ... 2,5 Nm 18 to 22 lb.in	0,8 ... 1,2 Nm 7 to 10,3 lb.in	2 ... 4 Nm 17,6 to 35,2 lb.in
	2 x 1 ... 2,5 mm ² 2 x 2,5 ... 6 mm ²	2 x 0,5 ... 1,5 mm ² 2 x 0,75 ... 2,5 mm ²	2,5...25 mm ²
	2 x 1 ... 2,5 mm ² 2 x 2,5 ... 6 mm ² max. 1 x 10 mm ²	2 x 0,5 ... 1,5 mm ² 2 x 0,75 ... 2,5 mm ²	2,5...25 mm ²
	2 x 1 ... 2,5 mm ² 2 x 2,5 ... 6 mm ² max. 1 x 10 mm ²	2 x 0,5 ... 2,5 mm ²	2,5...16 mm ²

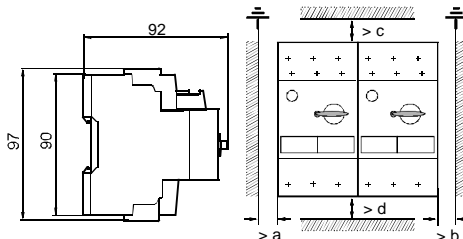
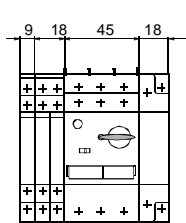

U ₀ (V)	a	b	c	d
240	9	9	30	30
400	9	9	30	30
440	9	9	30	30
500	9	9	30	30
690	30	30	50	50

3 Only materials which have low adverse environmental impact and which do not contain dangerous substances as specified in ROHS directive have been used in the product.

Ve výrobku jsou použity materiály s nízkým negativním dopadem na životní prostředí, které neobsahují zakázané nebezpečné látky dle ROHS.

SM253

Нáвод к использованию

SLOVENSKY

Spúšťáč motora - SM253

- 1** Montáž, obsluhu a údržbu môže vykonávať iba osoba s odpovedajúcou elektrotechnickou kvalifikáciou.
- 2** VYBAVENÉ
- 3** Vo výrobku sú použité materiály s nízkym negatívnym dopadom na životné prostredie, ktoré neobsahuje zakázané látky podľa ROHS

Инструкция по эксплуатации

ПО-РУССКИ

Автоматический выключатель защиты двигателя - SM253

- 1** Установку, обслуживание и уход может проводить только лицо с соответствующей электротехнической квалификацией.
- 2** снабжено
- 3** В изделии применены материалы с малым негативным влиянием на окружающую среду, которые не содержат запрещенные опасные вещества, указанные в директиве ROHS.